

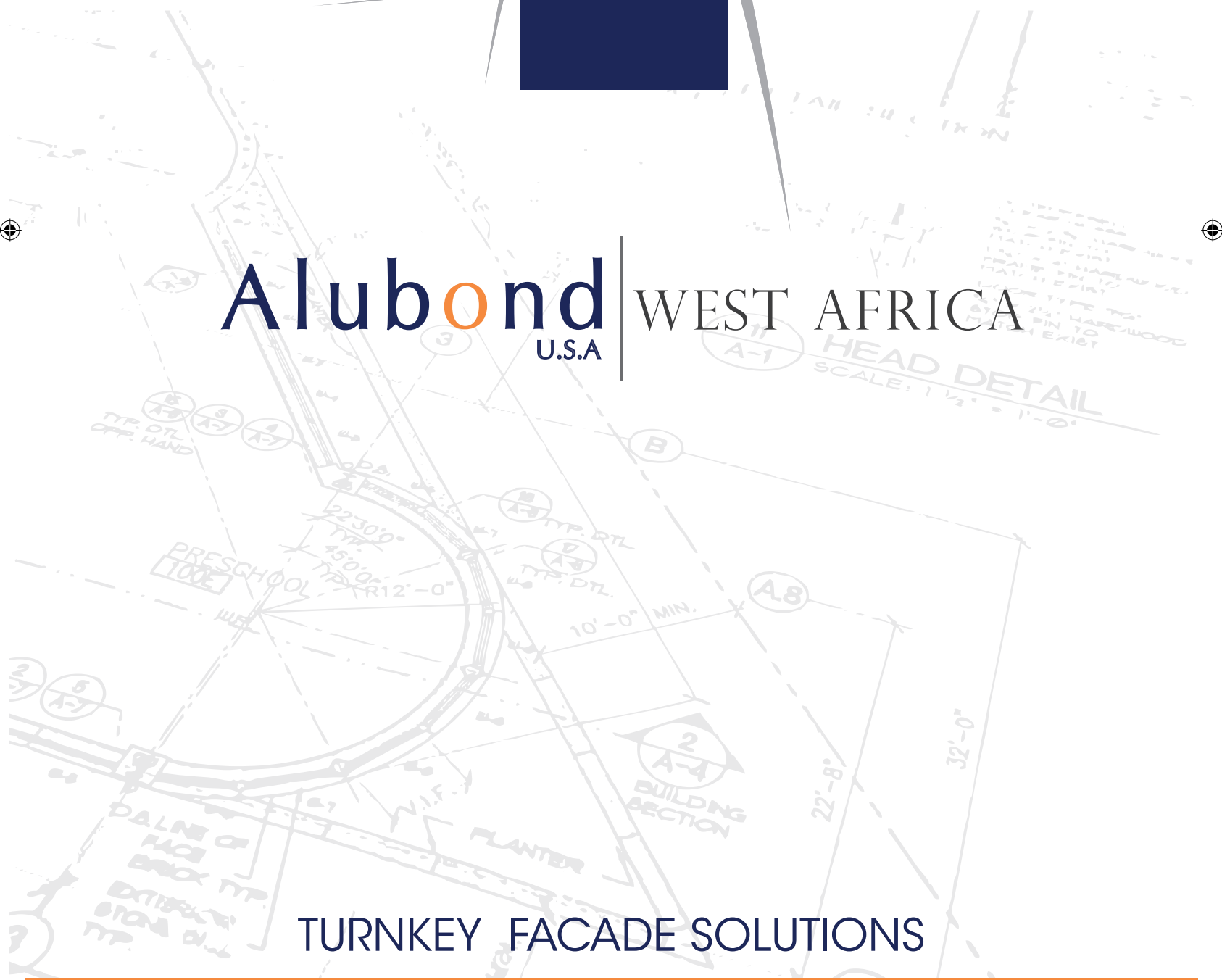

# Alubond | WEST AFRICA

U.S.A



TURNKEY FACADE SOLUTIONS



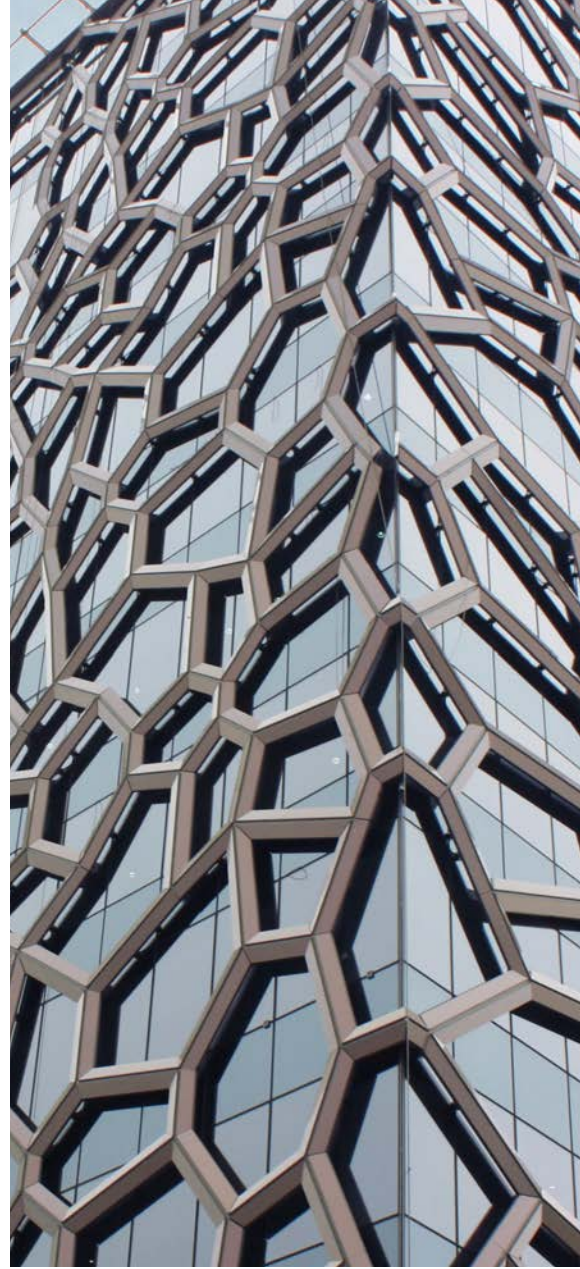
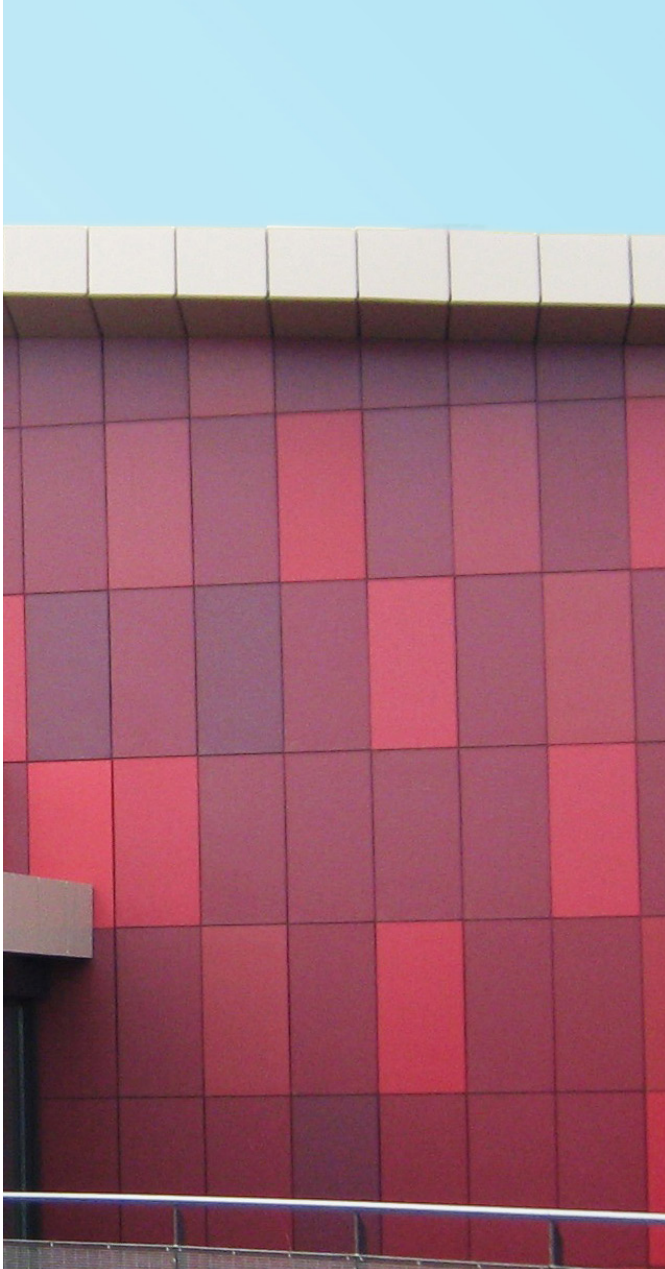

## MISSION

The objective of **Alubond West Africa** (AWA) is to design, fabricate and install state of the art facades throughout the West African region.

With the support of the Group's companies' infrastructure and expertise, we offer complete solutions to all façade engineering challenges.





**AWA** undertakes detailed inspection of work in progress at each stage of production, fabrication and installation.

**AWA** supports the clients with an experienced ONE-STOP-SHOP.

We firmly believe that dealing with **AWA** offers the client an integrated solution and eliminates the need of multiple contractors and suppliers.





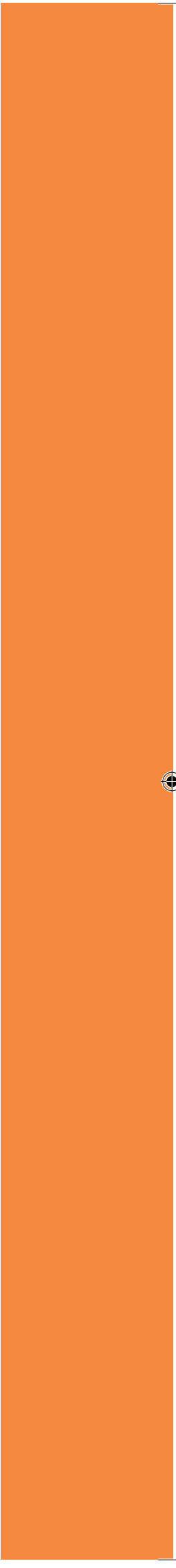



## COMPANY PROFILE

**Alubond West Africa** - a subsidiary of *Mulk Holdings International* ([www.mulkholdings.com](http://www.mulkholdings.com)) - is a company located in Accra (Ghana). The company was established to provide quality products and total façade engineering solutions.

**AWA** is one of the 17 companies in the Mulk Holdings International group, which has interests in various fields including:

- Manufacturing of building materials and energy saving products
- Solar Technology
- Health Care
- Real Estate

Mulk Holdings International has a global presence in more than eighty countries, and is based in Sharjah Hamriyah Free Zone and Ajman Free Zone (U.A.E.).

Eurocon Building Industries (part of the Group) produces Alubond U.S.A., which is the world's largest brand of Aluminium Composite Panels with a capacity of over 7 million m<sup>2</sup> in U.A.E. The company is ISO certified and has also won the prestigious MRM Business Excellence Award (Dubai) for the Best Foreign Factory in 2008, Ajman's 2009 Best Exporter of the Year award and Sharjah's Economic Excellence Award in the large manufacturing sector in 2010.

Alubond U.S.A. is a global leader in a variety of cladding applications - Exteriors, Interiors and Corporate Identity applications, Cladding substructure solutions and Solar power systems; with products like Alubond U.S.A. Fire Rated, Alubond U.S.A. Green, Alubond U.S.A. Nano Premium, Alubond U.S.A. Stainless Steel, Alubond U.S.A. Titanium, Alubond U.S.A. Lite, Alubond U.S.A. Interior Mirrors, ABTI Open Groove and Mechanical Systems, Alubond U.S.A. Parabolic Troughs and Photovoltaic System Boosters.

The strong R&D efforts have resulted in the development of new technologies for innovative applications in Acoustics, Solar and BIPV Market Segments.

Alubond U.S.A. ® has, over the years, emerged as the world's largest metal composite brand with additional production bases in Europe, Middle East and India. The new production bases in Sri Lanka and Saudi Arabia increased the installed capacity of metal composite panels to over 20,000,000 square meters and coil coating capacity to over 20,000 tones per annum

**AWA** delivers the highest standard of products and services and gives our clients access to total architectural solutions and materials.



# PRODUCTS & SERVICES

## Our Products

- Conventional/Structurally Glazed Curtain walls
- Aluminum Composite panels, Alubond U.S.A ®
- ABTI Substructure Systems
- Sliding and Casement Windows
- Hinged and Swing Doors
- Fixed Louvers and Louver Doors
- Frameless Shop Fronts and Spider Glazing.
- Handrails and Glass Balustrades
- Skylights

## Our Services

- Sales & Contract Development
- Facade Design and Engineering
- Manufacturing
- Supply and Installation

**AWA** Offers a Total Solution Concept, which is designed to offer a package of engineering, supply and installation for exterior façades.







# PRODUCTS



## Conventional / Structurally Glazed Curtain walls

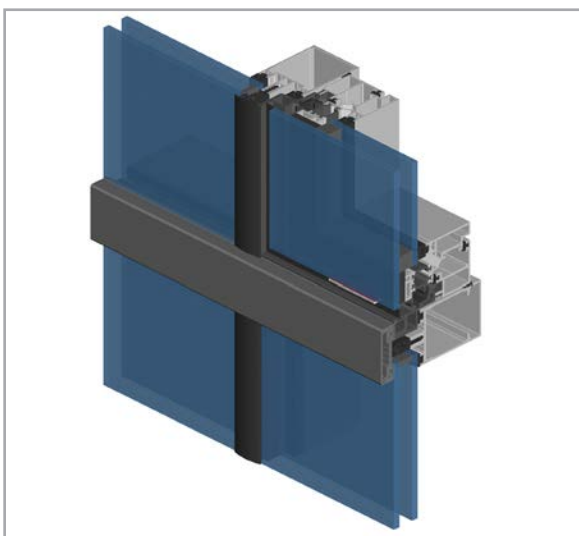
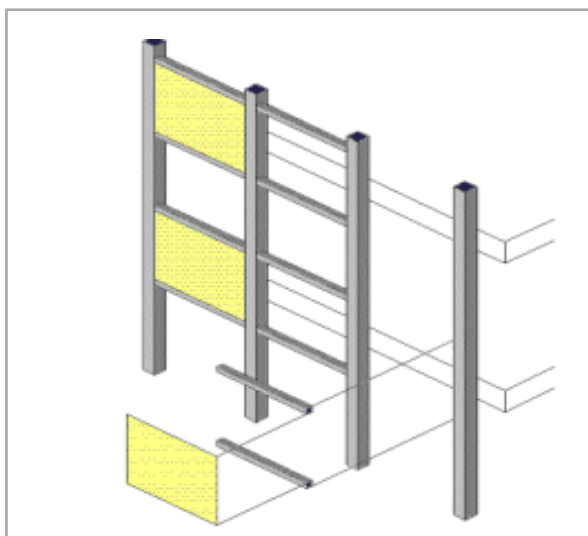
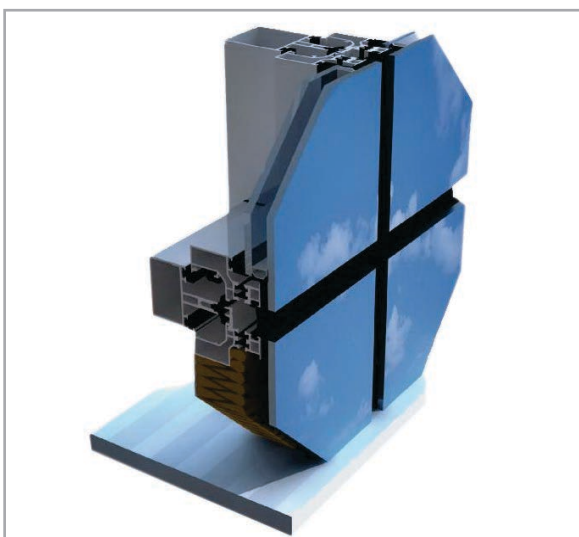
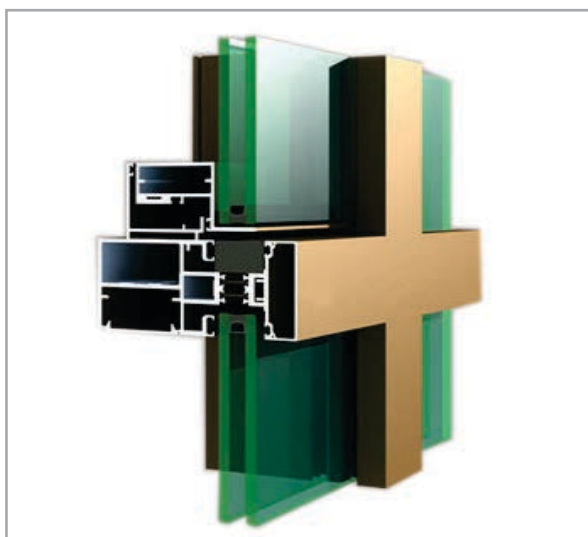
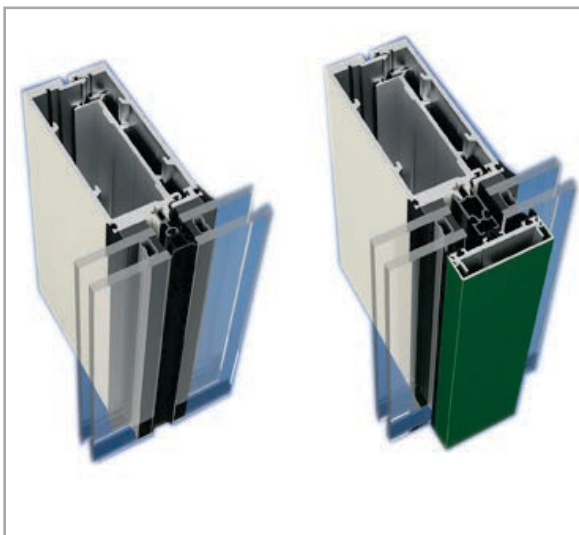



# PRODUCTS

Aluminium Composite Panels, Alubond U.S.A ®



The World's Largest Brand







# PRODUCTS







# PRODUCTS

ABTI SUBSTRUCTURE

## abti

FIRE RATED SUBSTRUCTURE SYSTEMS

Open Groove Hook On System







# PRODUCTS



## Sliding and Casement Windows





# PRODUCTS

## Hinged & Swing Doors







# PRODUCTS



## Fixed Louvers and Louver Doors

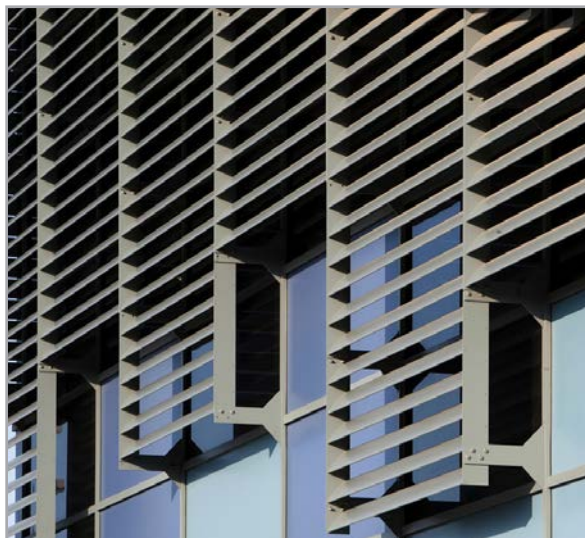



# PRODUCTS

Frameless Shop Fronts and Spider Glazing.

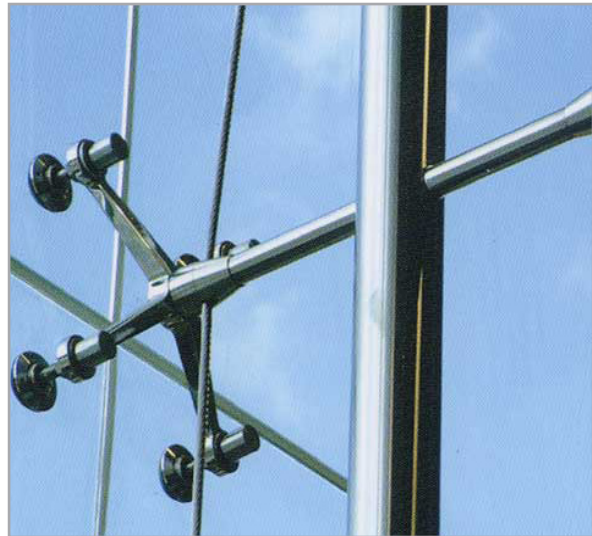





# PRODUCTS



## Handrails and Glass Balustrades

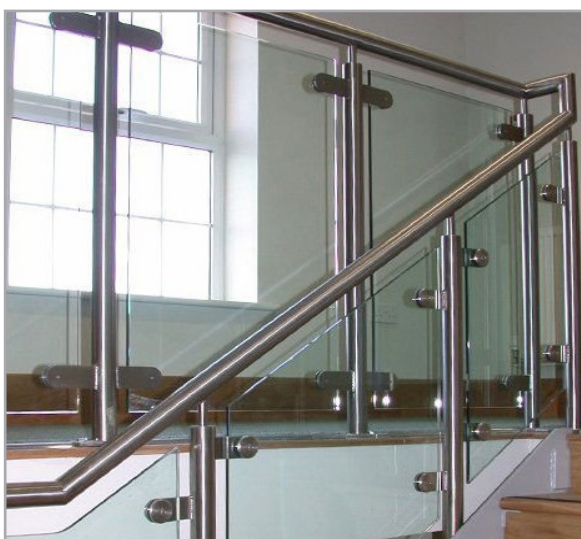
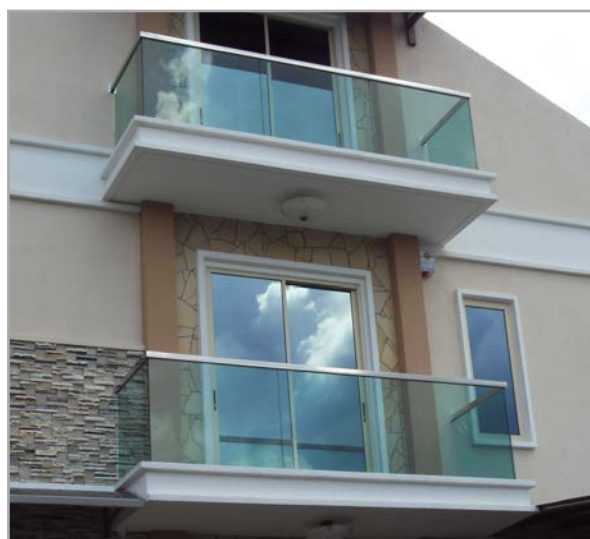
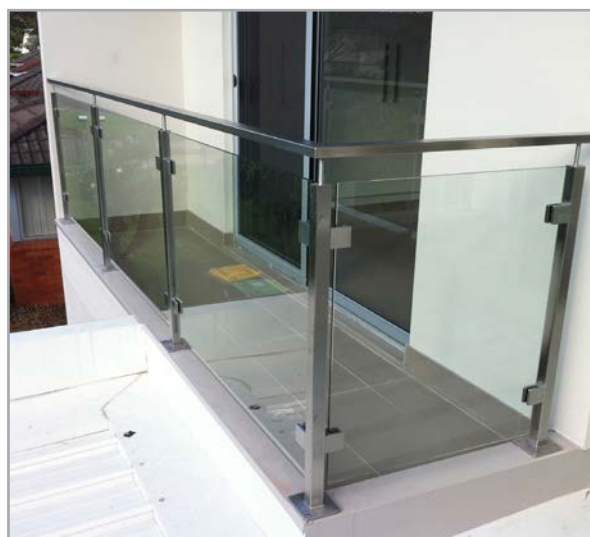



# PRODUCTS

## Skylights





# SERVICES

## TURNKEY FACADE SOLUTIONS

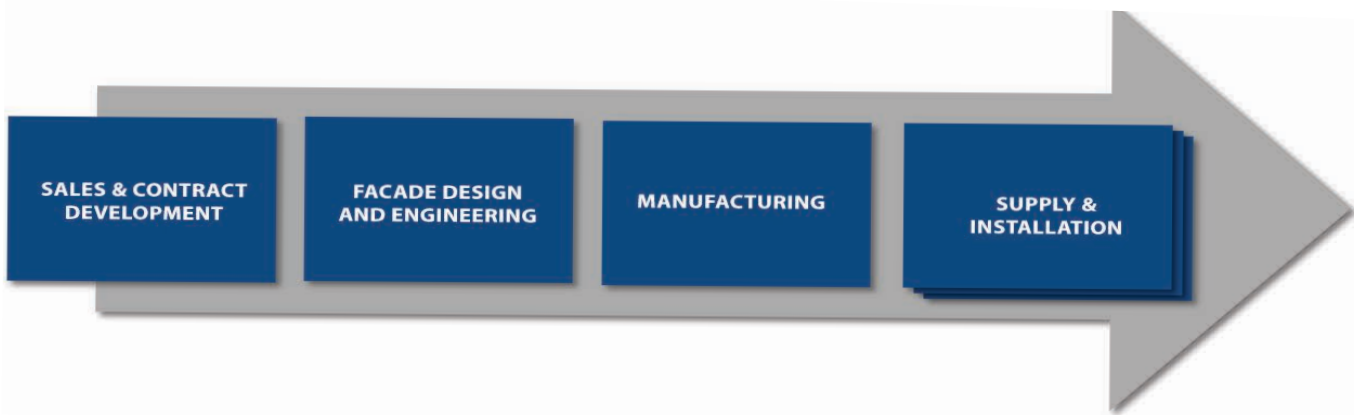
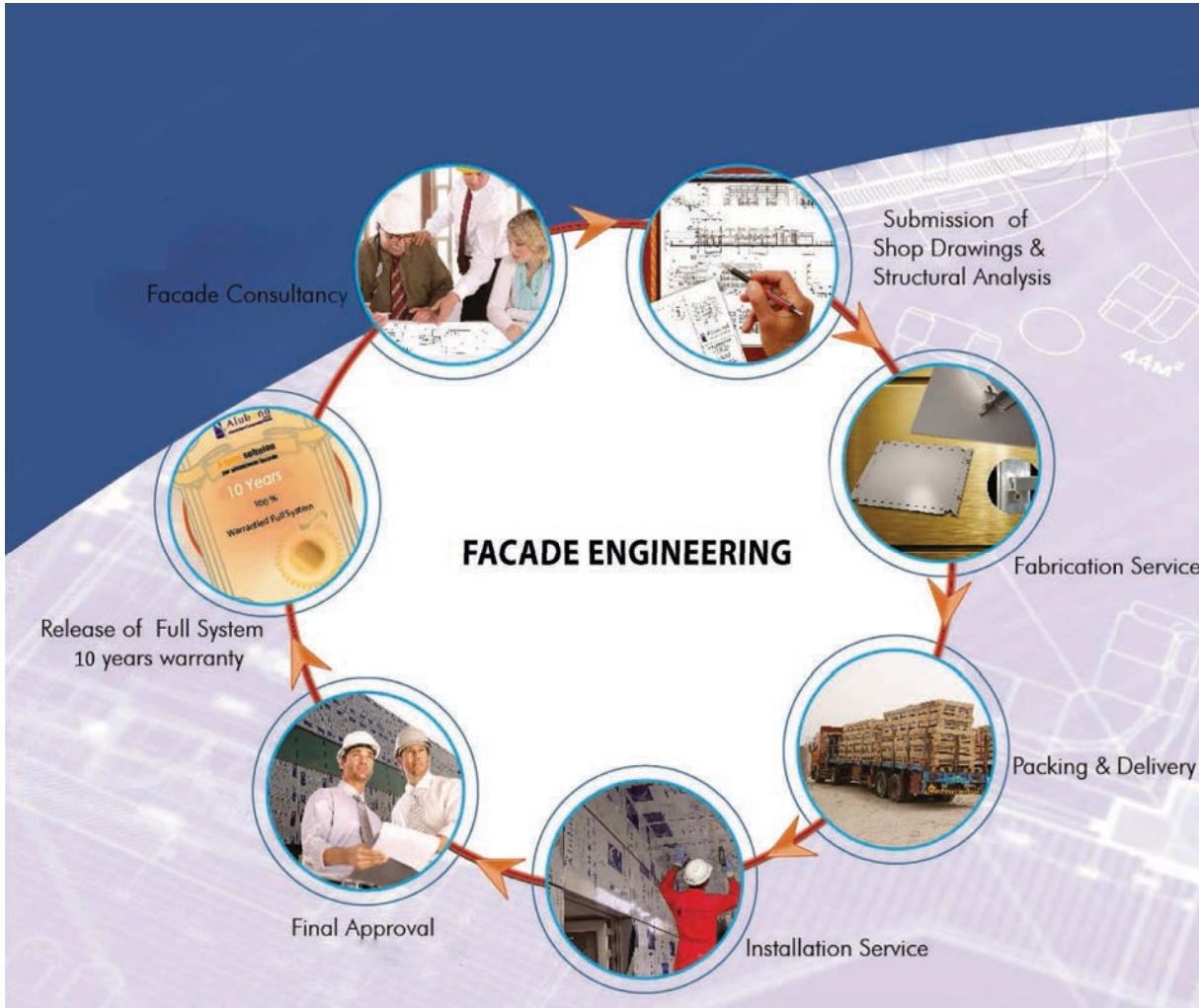





# CURRENT PROJECTS



ABD BANK, ABIDJAN (COTE D'IVORIE)

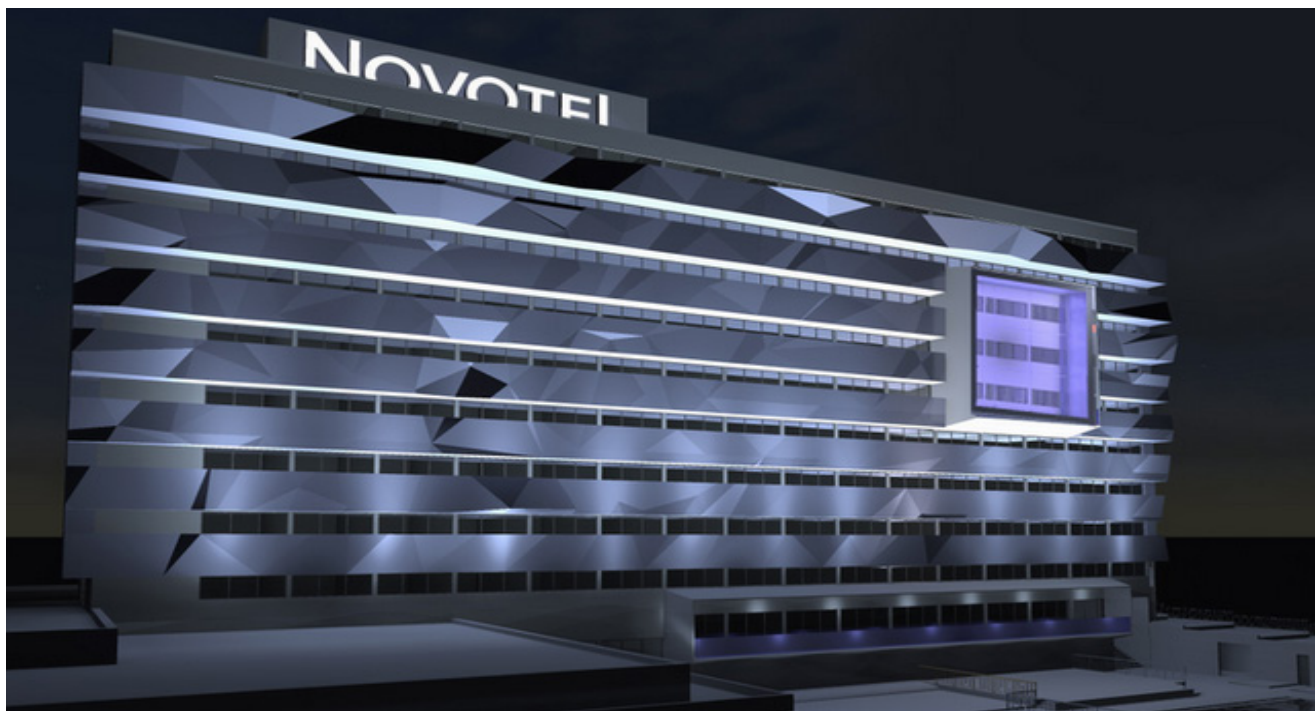

NOVOTEL, ABIDJAN (COTE D'IVORIE)





ATLANTIC TOWER, ACCRA (GHANA)



SUNCITY, ACCRA (GHANA)







# FACTORY MACHINES



Double Head Cutting Machine



Copy Router



Vertical Saw ACP Cladding Machine



Corner Crimping Machine



Sheet Metal Shearing Machine

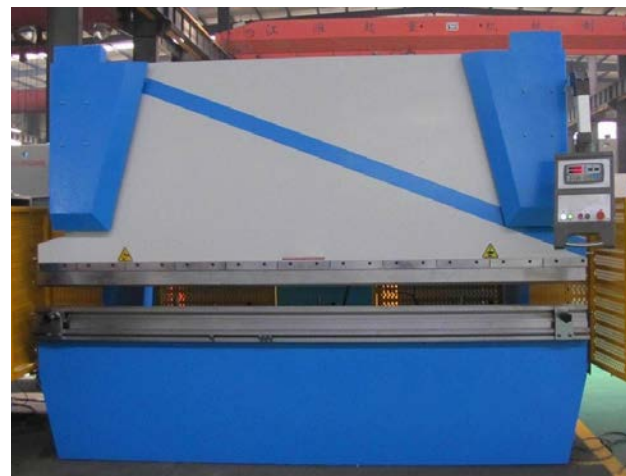

Sheet Metal Bending Machine





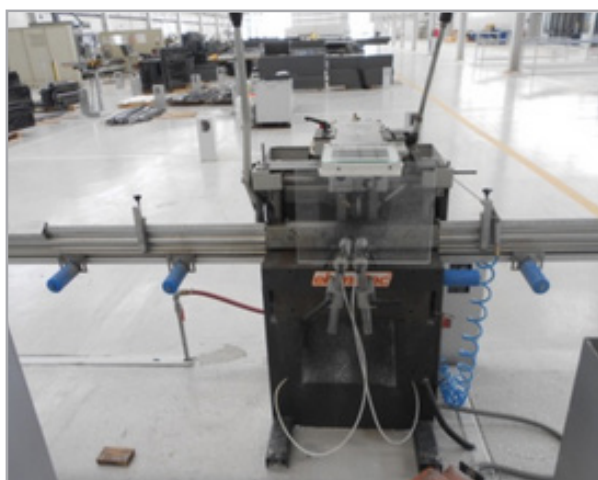

Freezing Machine



Structural Silicone Extruder



CNC Master Router Machine



Glass Cutting Table



Automatic Cutting Machine



Punching Power Press





# GLOBAL PROJECTS



Airports



INTERNATIONAL AIRPORT, INDIA



INTERNAT



Petrol Stations



NIS PETROL STATION, SERBIA

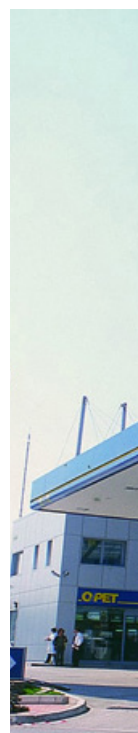

OPET PE







INTERNATIONAL AIRPORT, DUBAI



ADNAN MENDERES, TURKEY



O-PET PETROL STATION, TURKEY



EPPCO PETROL STATION, DUBAI







# GLOBAL PROJECTS



Hotels



JW MARIOTT, DUBAI



YAS ISLAND HOTEL, ABU DHABI



Malls



FORUM SHOPPING CENTRE, SERBIA



SOUTH MALL, SAUDI ARABIA







W HOTEL, BARCELONA

ADDRESS HOTEL, DUBAI



SAMA MALL, KUWAIT



# GLOBAL PRESENCE

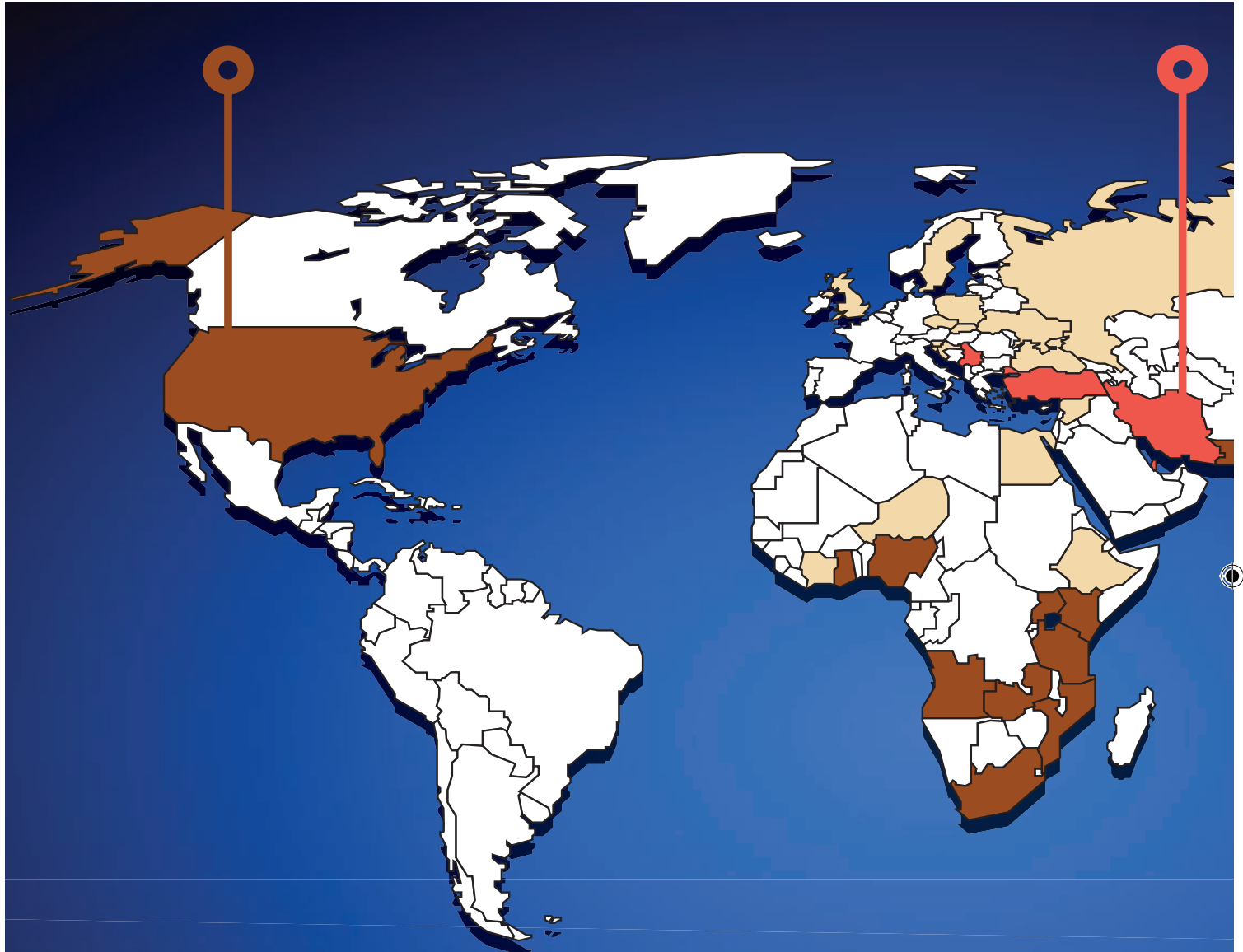

## USA

American Building Technologies Inc, Illinois  
Mulk Enpar Renewable Energy Inc, Illinois

## Europe

Alubond Europe, Serbia  
Metal Plast Industries, Serbia

## Africa

Alubond East Africa - Nairobi, Kenya  
Alubond West Africa - Accra, Ghana



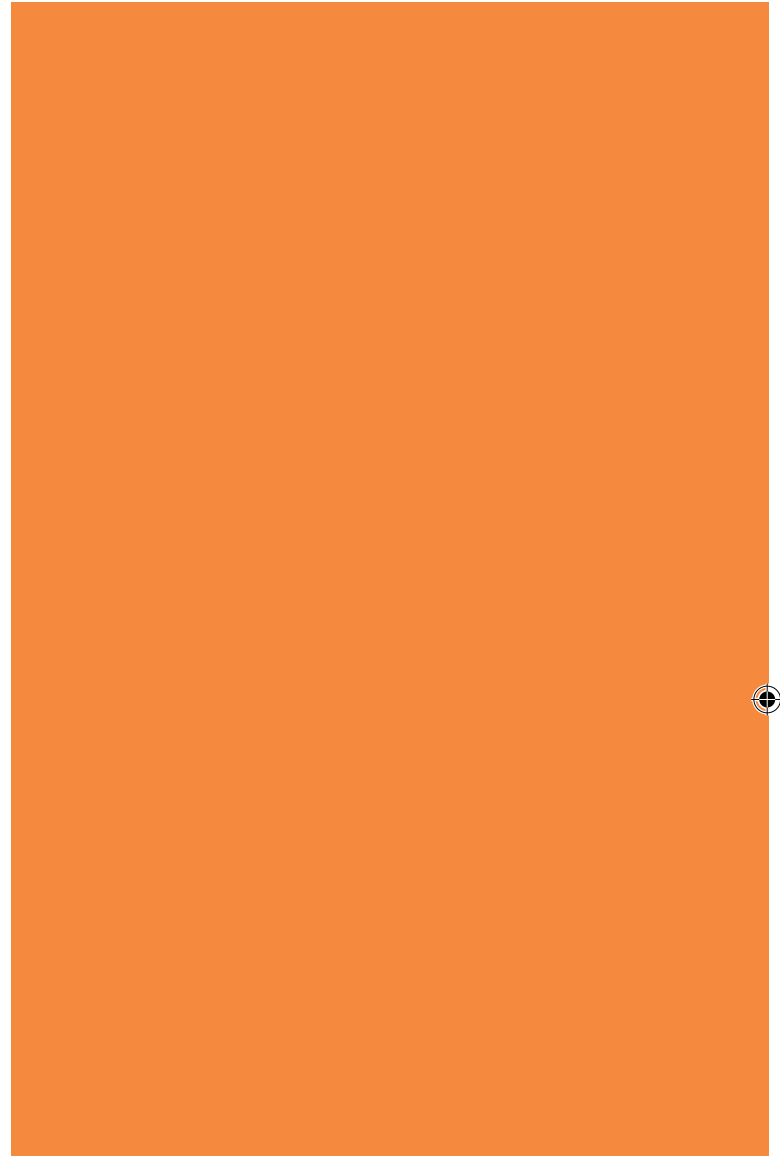

### UAE

Eurocon Building Industries, Sharjah  
 Alubond Middle East L.L.C, Ajman  
 Alubond Solid Surface, Sharjah  
 Alubond Marketing L.L.C, Dubai  
 Coil Cote F.Z.E, Sharjah  
 Mulk Decorative Glass & Metal - Ajman  
 Eurocon Metal Industries - Ajman,  
 M Square Design Studio - Sharjah,

### Saudi Arabia

Alubond Saudi Arabia, Dammam

### Oman

Metal Plast Industries, Buraimi

### India

American Building Technologies (P)Ltd.  
 Alubond Dacs India (P)Ltd.  
 Alubond Accoustics (P)Ltd.  
 Mulk Real Estate

### Turkey

Alubond Turkey





## CONTACT US

---



**Alubond** | WEST AFRICA  
U.S.A

26 Tema Motorway, Spintex Road,  
Accra, GHANA

Tel : +233 24 111 4 222  
Email : [salesghana@alubond.com](mailto:salesghana@alubond.com)  
Website : [www.alubondwestafrica.com](http://www.alubondwestafrica.com)

[www.mulkhholdings.com](http://www.mulkhholdings.com) / [www.alubond.com](http://www.alubond.com)

